

Power is our commodity, the world is our market !

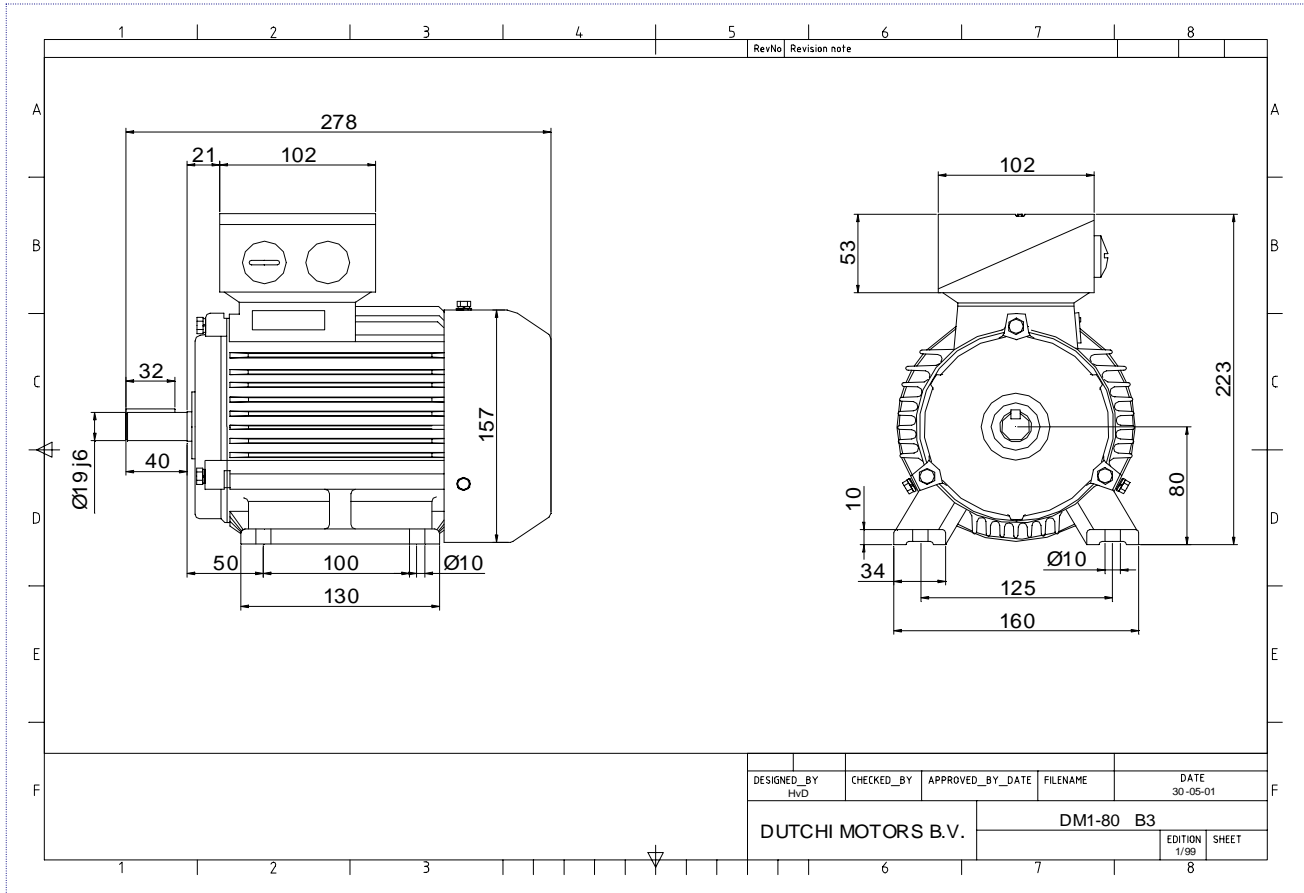

Specification	IEC 60034-1
Manufacturer	Dutchi Motors B.V.
Motor type	DM1- 80 G6
Rated power	0,55 kW S1 duty
Speed	890 r.p.m
Voltage	230 / 400 V
Frequency	50 Hz
Connection	Δ / Y
Amps full load	2,98 / 1,72 A
Amps no-load(400V)	1,30 A
Enclosure	IP 55
Insulation Class	F (temp. rise B (80 K))
Max. coolant temp.	40°C
Max. altitude	1.000 mtr, above sea level
Comment	3 x PTC 150°C
Cable entries	2 x M25x1,5 + 1 x M20x1,5 (ptc)
Feature	Cast-iron motor
Weight	19,0 kg
Catalog no.	11126055D
Warranty	12~18 months

Efficiency class	N/A			
Load data	100%	75%	50%	25%
Efficiency	64,8	64,1	62,0	48,4 %
Power factor	0,71	0,61	0,52	0,35
Sound pressure level (1m)				47,0 dB(A)
Resistance R20 (open)				14,92 Ω
Resistance R20	Y		29,83	Ω
Full load torque				5,90 Nm
DOL Starting torque vs FL torque				2,10
DOL Pull up torque vs FL torque				1,45
DOL Pull out torque vs FL torque				2,69
Star-Delta Starting torque vs FL torque				Y - motor
Star-Delta Pull up torque vs FL torque				Y - motor
Star-Delta Pull out torque vs FL torque				Y - motor
DOL Starting current vs FL current				3,53
Star Delta Starting current vs FL current				Y - motor
Rotor Inertia				0,0021 kgm ²
Bearing DE				6204 - ZZ
Bearing NDE				6204 - ZZ

Extras / Options :

WI	Change	date	sign.
Dutchi Motors B.V. P.O. Box 5390 NL-6802 EJ ARNHEM Tel : +31-(0)26 - 3541 600 Fax : +31-(0)26 - 3541 650		Description	date
		Drawing made by :	19-04-04
		dutchi.motors@dutchi.nl www.dutchi.com	

Power is our commodity, the world is our market !

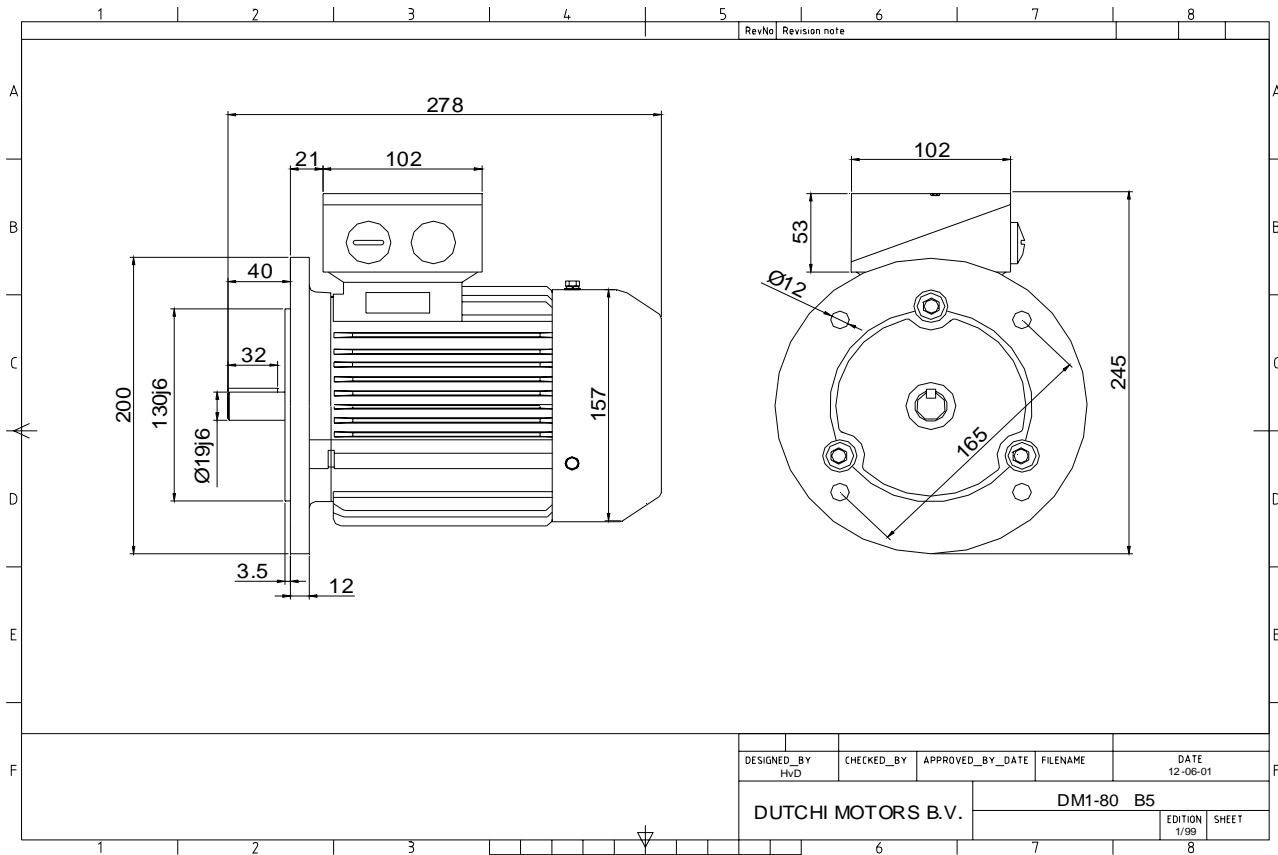

Specification	IEC 60034-1
Manufacturer	Dutchi Motors B.V.
Motor type	DM1- 80 G6
Rated power	0,55 kW S1 duty
Speed	890 r.p.m
Voltage	230 / 400 V
Frequency	50 Hz
Connection	Δ / Y
Amps full load	2,98 / 1,72 A
Amps no-load(400V)	1,30 A
Enclosure	IP 55
Insulation Class	F (temp. rise B (80 K))
Max. coolant temp.	40°C
Max. altitude	1.000 mtr, above sea level
Comment	3 x PTC 150°C
Cable entries	2 x M25x1,5 + 1 x M20x1,5 (ptc)
Feature	Cast-iron motor
Weight	19,0 kg
Catalog no.	11226055D
Warranty	12~18 months

Efficiency class	N/A			
Load data	100%	75%	50%	25%
Efficiency	64,8	64,1	62,0	48,4 %
Power factor	0,71	0,61	0,52	0,35
Sound pressure level (1m)				47,0 dB(A)
Resistance R20 (open)				14,92 Ω
Resistance R20	Y		29,83	Ω
Full load torque				5,90 Nm
DOL Starting torque vs FL torque				2,10
DOL Pull up torque vs FL torque				1,45
DOL Pull out torque vs FL torque				2,69
Star-Delta Starting torque vs FL torque				Y - motor
Star-Delta Pull up torque vs FL torque				Y - motor
Star-Delta Pull out torque vs FL torque				Y - motor
DOL Starting current vs FL current				3,53
Star Delta Starting current vs FL current				Y - motor
Rotor Inertia				0,0021 kgm ²
Bearing DE				6204 - ZZ
Bearing NDE				6204 - ZZ

Extras / Options :

WI	Change	date	sign.
Dutchi Motors B.V. P.O. Box 5390 NL-6802 EJ ARNHEM Tel : +31-(0)26 - 3541 600 Fax : +31-(0)26 - 3541 650		Discription Drawing made by :	date 19-04-04 sign. HvD
dutchi.motors@dutchi.nl www.dutchi.com			